



1



ZN091-ZIL.GG.V5P1 | 180680 | Portfolio STD-WW | FE2owlet ECblue

Technical Description FE2owlet with ZPlus

Range ZN

Standard design with AC motor

- Profiled, sickle shaped blades designed with bionical know how
- Sizes 450 ... 900 mm (in 6 standard sizes)
- Highest efficiency with optimized full bell mouth with guide vane and diffusor
- Integrated speed control
- ZIEHL-ABEGG FE2owlet ECblue with ZPlus fans can be used with active temperature management from -35°C* up to 70°C.

Mains voltage motor size B:

- 1~ 200...277 V; 50/60 Hz

Mains voltage motor size D:

- 1~ 200...277 V; 50/60 Hz
- 3~ 200...240 V; 50/60 Hz
- 3~ 380...480 V; 50/60 Hz

Mains voltage motor size G:

- 3~ 200...240 V; 50/60 Hz
- 3~ 380...480 V; 50/60 Hz

Thermal class:

- THCL 155

Protection:

- IP55

Material of impeller:

- Aluminium die-cast or high performance composite material

Painting:

- Fan unpainted
- ZPlus made from high performance composite material in black, unpainted

On request:

- Guard grille suction side
- Additional diffusor (increase of efficiency)
- Different paintings
- Heater (de-icing of the nozzle)
- 4 different built in versions

FANselect



***Continuous operation with occasional starts (S1) according to DIN EN 60034-1: 2011-02. Occasional starting between -35 ° C and -25 ° C is permissible. Permanent operation below -25 ° C only possible with special bearings for refrigeration applications on request.**

data ventilátoru

24.09.2022

verze FANselect V 1.01 (220922), AMCA V 1.03 September, 2021
RLT V 1.00 Dezember, 2021 / 1.22.09.22 | 68370 | (uživatel ZAFS58370)

1



typ	ZN091-ZIL.GG.V5P1
artiklové č.	180680 Portfolio STD-WWW

technická data

motor	ECblue
Efficiency class	IE5
napájení	-
maximální okolní teplota (t_r)	°C
účinnost η_{statA}	%
účinnost N_{actual} N_{SOLL}	66,5 40
ErP - třída	2015 EC regulátor integrovaný
grille influence	pressure side measured

data ventilátoru

SFP-class SFP-třída (P_{SFP})	- Ws/m^3	1 147
průtok vzduchu (q_v)	m^3/h	27956
tlak, stat. (p_{sF}) celk. (p_F)	Pa	2 84
elektrický příkon (P_{sys})	W	1143
účinnost syst., stat. ($\eta_{sF,sys}$) celk. ($\eta_{F,sys}$)	%	1.4 57.0
otáčky ventilátoru (n) max. (n_{max})	1/min	929 930
otáčky ventilátoru, pož. hodn. ($\%n_{max}$)	%	100
frekvence v prac.bodě (f_{DP}) (f_{max})	Hz	50 60
napětí v pracovním bodě (U_{DP})	V	400
proud v pracovním bodě (I_{DP})	A	1.81
hlučnost, sací strana ($L_{w(A),s}$) ($L_{w,s}$)	dB	81 86
hlučnost, výtlačná strana ($L_{w(A),6}$) ($L_{w,6}$)	dB	81 86
rozměry ($\text{š} \times \text{v} \times \text{d}$)	mm	1063 x 1063 x 385
hmotnost výrobku (m_{Pr})	kg	40.4

PF:PF_50; Ano:180680; STol:+-10 %



charakteristika / hlučnost

24.09.2022

verze FANselect V 1.01 (220922), AMCA V 1.03 September, 2021
RLT V 1.00 Dezember, 2021 / 1.22.09.22 | 68370 | (uživatel ZAFS58370)

1 ZN091-ZIL.GG.V5P1

Measured in ZPlus with pressure side guard grille in air flow direction V in installation type A according to ISO5801

180680 | Portfolio STD-WW měřená hustota 1.16 [kg/m³]

vzduchový výkon p_{sF}

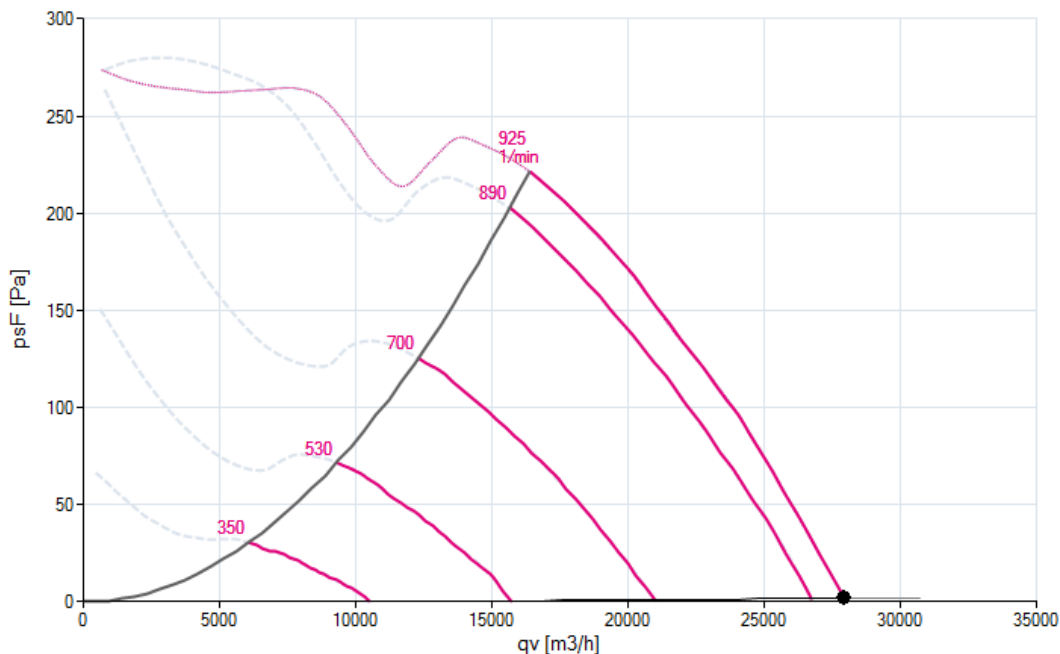

hlučnost ($L_{w(A),5}$)

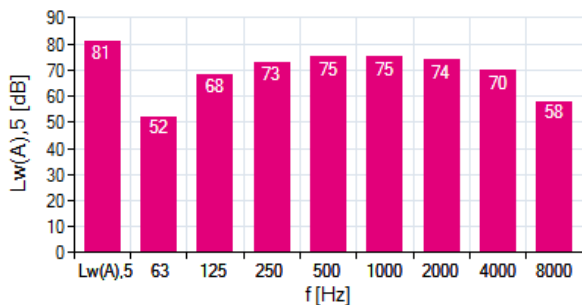

hlučnost ($L_{w(A),6}$)

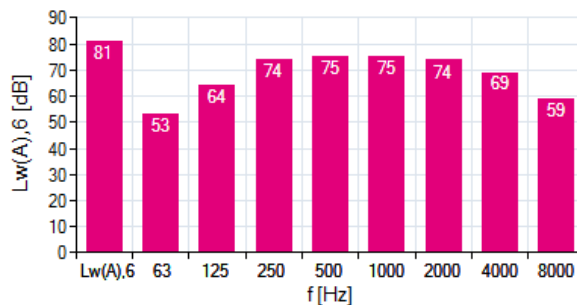

1 ZN091-ZIL.GG.V5P1

f [Hz]	sum	63	125	250	500	1000	2000	4000	8000
$L_{w(A),5}$	81	52	68	73	75	75	74	70	58
$L_{w,5}$	86	75	82	81	78	75	72	69	59

f [Hz]	sum	63	125	250	500	1000	2000	4000	8000
$L_{w(A),6}$	81	53	64	74	75	75	74	69	59
$L_{w,6}$	86	76	78	82	78	75	73	68	60

účinnost / příkon

24.09.2022

verze FANselect V 1.01 (220922), AMCA V 1.03 September, 2021
 RLT V 1.00 Dezember, 2021 / 1.22.09.22 | 68370 | (uživatel ZAFS58370)

1

ZN091-ZIL.GG.V5P1

Measured in ZPlus with pressure side guard grille in air flow direction V in installation type A according to ISO5801

180680 | Portfolio STD-WW

měřená hustota 1.16 [kg/m³]

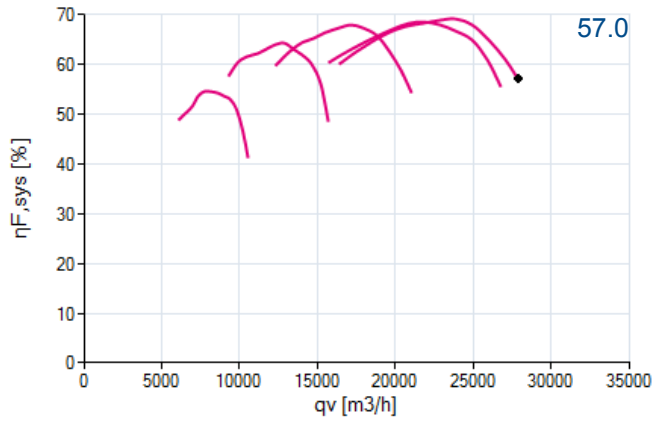
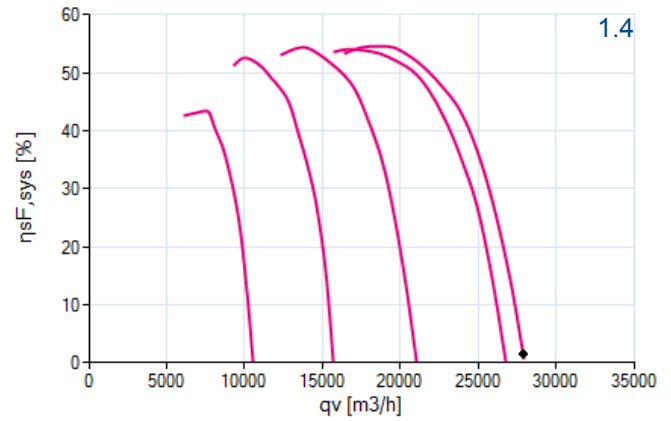
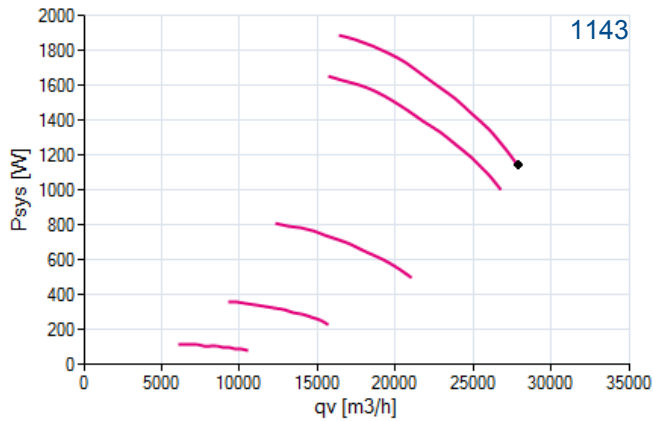
účinnost $\eta_{F,sys}$ účinnost $\eta_{SF,sys}$ příkon P_{sys} 



nominální hodnoty

24.09.2022

verze FANselect V 1.01 (220922), AMCA V 1.03 September, 2021
RLT V 1.00 Dezember, 2021 / 1.22.09.22 | 68370 | (uživatel ZAFS58370)

1



ZN091-ZIL.GG.V5P1

180680

3~ 380-480V 50Hz P1 1.90kW
 3.10-2.50A 930/MIN 60°C
 3~ 380-480V 60Hz P1 1.90kW
 3.10-2.50A 930/MIN 60°C
 IP55 THCL155

výkres

24.09.2022

verze FANselect V 1.01 (220922), AMCA V 1.03 September, 2021
RLT V 1.00 Dezember, 2021 / 1.22.09.22 | 68370 | (uživatel ZAFS58370)

1



ZN091-ZIL.GG.V5P1

180680



schéma zapojení

24.09.2022

verze FANselect V 1.01 (220922), AMCA V 1.03 September, 2021
RLT V 1.00 Dezember, 2021 / 1.22.09.22 | 68370 | (uživatel ZAFS58370)

1

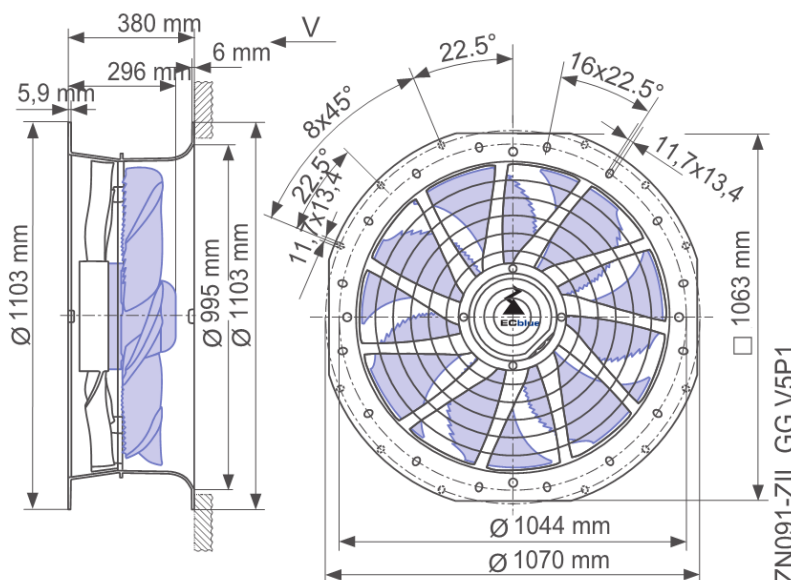

ZN091-ZIL.GG.V5P1

180680

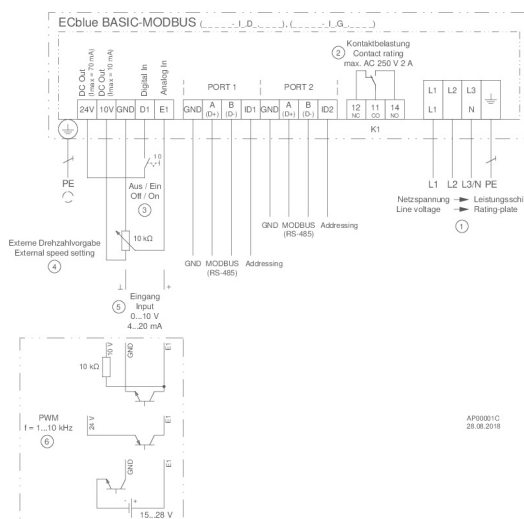



příslušenství

verze FANselect V 1.01 (220922), AMCA V 1.03 September, 2021
RLT V 1.00 Dezember, 2021 / 1.22.09.22 | 68370 | (uživatel ZAFS58370)

24.09.2022



typ	ZN091-ZIL.GG.V5P1
artiklové č.	180680



Series

ZN

Design

FE2owlet-ECblue with ZAPlus



Specification

- Direct-driven axial fan
- Aerodynamic-optimised, sickle-blade profile, patterned with serrated trailing edge and winglets on the blade outer edge for energy and noise-optimised operation
- High efficient external rotor motor with innovative bionic blade in die-cast aluminium or composite injection moulded
- Highest efficiency with an optimized full bell mouth with guide vane and diffusor
- Impeller: Ø 450 – 1000 mm
- Balanced in Class G 6.3 acc DIN ISO 21940, dynamic on two levels.
- Any fitting position
- Drive motor in external rotor principle, sealed in protection class IP55
- Version with integrated electronics (IP65)
- Fan overtemperature protection through active temperature management
- Motor painted in RAL 5002
- Thermal class THCL 155
- The motor efficiency class complies with IE5
- The permissible ambient temperature is -35°C* to max. +40°C (see data sheet)
- Maintenance-free ball bearings sealed on both sides with long-term lubrication
- Fan characteristic curve refer to measurements made on a combined air performance and acoustic test rig according DIN EN ISO 5801, or AMCA 210-99
- Make the electrical connection according to the operating instructions
- Highest efficiency with optimized full bell mouth with guide vane and diffusor
- ZAPlus made from high performance composite material
- Modbus integrated as standard

System components

Guard grille, inlet rings

Technical data

Fan type	_____	
Fan size (Ø)	_____	mm
Design	_____	
Air flow (q_v)	_____	m ³ /h
Static pressure rise (Δp_{sF})	_____	Pa
Rated voltage (U)	_____	V
Mains frequency (f)	_____	Hz
Rated power (P_N)	_____	kW
Efficiency (η_{sF})	_____	%
Rated speed (n)	_____	min ⁻¹
Media temperature (t_R)	_____	°C
Sound power level (L_{WA})	_____	dB(A)
Weight (m)	_____	kg

Further designs on request

FANselect



All frame sizes are available in various grill and nozzle versions (designs).

*Continuous operation with occasional starts (S1) according to DIN EN 60034-1: 2011-02. Occasional starting between -35 ° C and -25 ° C is permissible. Permanent operation below -25 ° C only possible with special bearings for refrigeration applications on request.

Life-Cycle-Costs

24.09.2022

verze FANselect V 1.01 (220922), AMCA V 1.03 September, 2021
RLT V 1.00 Dezember, 2021 / 1.22.09.22 | 68370 | (uživatel ZAFS58370)

typ

artiklové č.

1 ZN091-ZIL.GG.V5P1

180680

		1
elektrický příkon (P_1)	W	1143
otáčky ventilátoru, max. (n_{max})	%	100
průtok vzduchu (q_v)	m ³ /h	27956
tlak, stat. (p_{sF})	Pa	2

náklady		
1 roky	EUR	0
2 roky	EUR	0
3 roky	EUR	0
4 roky	EUR	0
5 roky	EUR	0

načíst profil			
prov. hodiny	% otáček		
1000	100	%	
1000	50	%	
1000	25	%	
		%	
5760	zbývající doba		
náklady na energii	0.10	EUR/kWh	
inface	00	%	

