

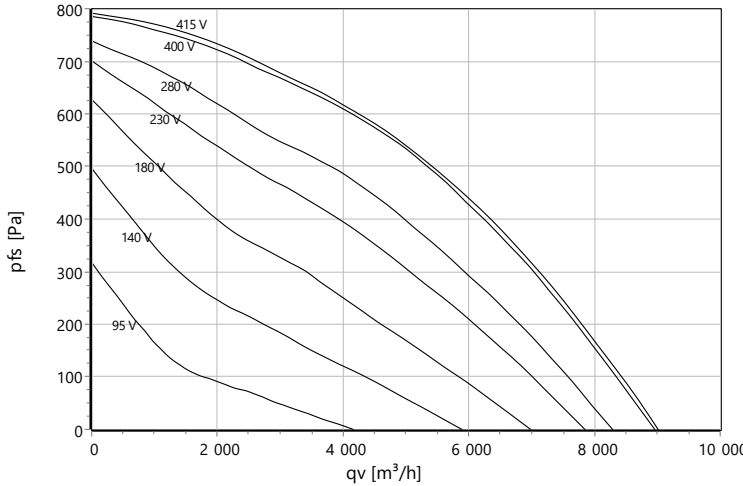

Typ: **UNO-ME 80-500-4 D FU**  
 Výfuk nahoru - regulovatelný pomocí FM  
 Art.-è.: F09-50025



**Charakteristika:**



p: 1,15 kg/m³

**Jmenovité údaje:**

Δl 4 %

U [V]	f [Hz]	C [μF]	Pe [kW]	IN [A]	nN [U/min]	tR [°C]	k10 [m²s/h]	IA / IN	IP	m [kg]
400 D	50	-	1,5	3	1380	-25 .. +90	-	4,9	IP 54	78

**Hlukové údaje:**

Frekvence	Σ	63Hz	125Hz	250Hz	500Hz	1kHz	2kHz	4kHz	8kHz	Vzdálenost	1 m	4 m
LwA(A,in) [dB(A)]	-3	-43	-14	-8	-6	-7	-6	-11	-21	LpA(A,in) [dB(A)]	-10	-20
LwA(A,out) [dB(A)]		-38	-16	-8	-7	-5	-6	-14	-22	LpA(A,out) [dB(A)]	-7	-17
LwA(D,cas) [dB(A)]	-15	-44	-11	-4	-7	-8	-9	-15	-23	LpA(D,cas) [dB(A)]	-22	-32

**Schéma zapojení:**

Drehstrommotor in Δ-Schaltung mit Thermostatschalter (TB).  
 Drehrichtungsänderung durch Vertauschen von 2 Phasen.

**Three phase motor in delta connection with thermostatic switch (TB). Changing of rotation direction by interchanging of 2 phases.**

**Moteur triphasé branché en triangle avec interrupteur thermostatique (TB). Changement de sens de rotation par inversion de deux phases.**

TK3-20004

U<sub>1</sub> braun / brown / brun  
 V<sub>1</sub> blau / blue / bleu  
 W<sub>1</sub> schwarz / black / noir  
 U<sub>2</sub> rot / red / rouge  
 V<sub>2</sub> grau / grey / gris  
 W<sub>2</sub> orange / orange / orange  
 TB weiß / white / blanc  
 PE gelb-grün / yellow-green / jaune-vert

01.006

max teplota okolí 40°C

**Výkres:**

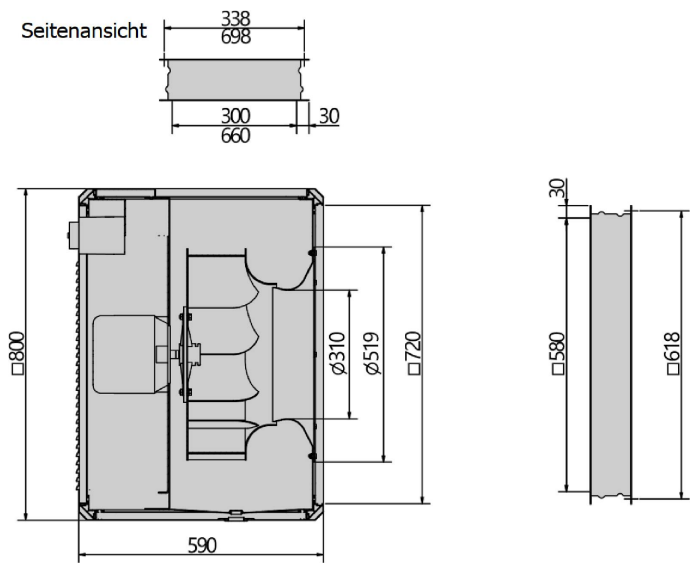



Typ: **UNO-ME 80-500-4 D FU**  
Výfuk nahoru - regulovatelný pomocí FM  
Art.-č.: F09-50025



Art.-č.	Označení	Počet
F09-50025	UNO-ME 80-500-4 D FU - výfuk nahoru - 400V, 50Hz	1



Typ: **UNO-ME 80-500-4 D FU**  
 Výfuk nahoru - regulovatelný pomocí FM  
 Art.-č.: F09-50025



Seitenansicht

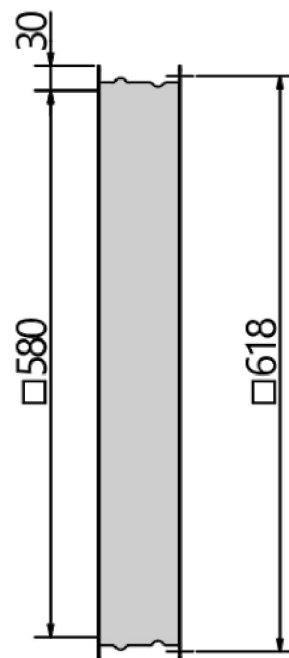
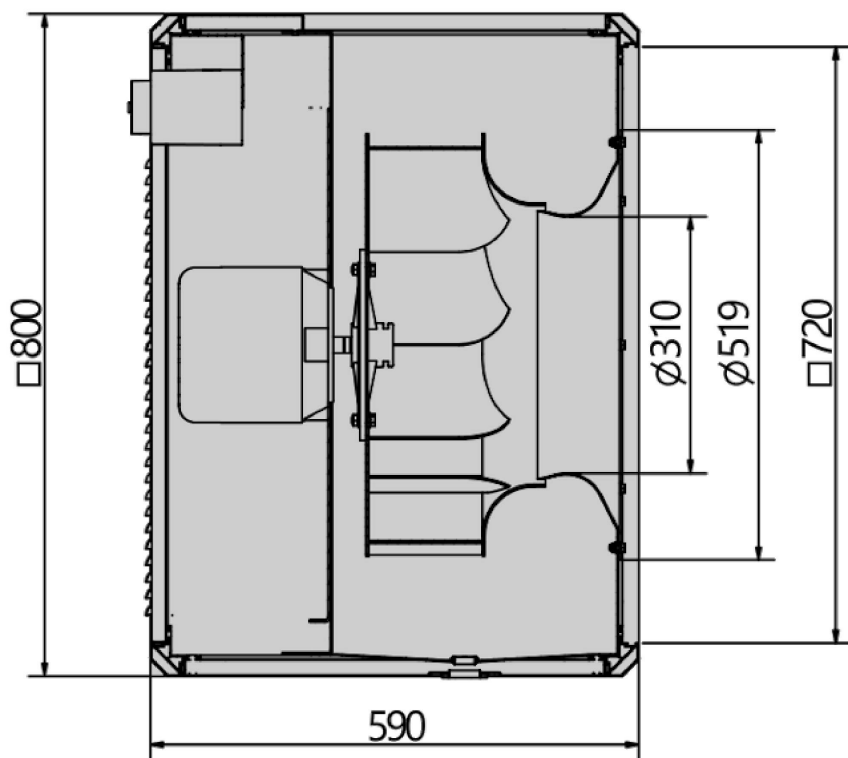
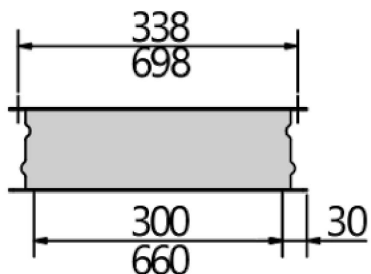



Typ: **UNO-ME 80-500-4 D FU**  
 Výfuk nahoru - regulovatelný pomocí FM  
 Art.-č.: F09-50025



Drehstrommotor in  $\Delta$ -Schaltung mit Thermostatschalter (TB).  
 Drehrichtungsänderung durch Vertauschen von 2 Phasen.

**Three phase motor in delta connection with thermostatic switch (TB). Changing of rotation direction by interchanging of 2 phases.**

***Moteur triphasé branché en triangle avec interrupteur thermostatique (TB). Changement de sens de rotation par inversion de deux phases.***

TK3-20004

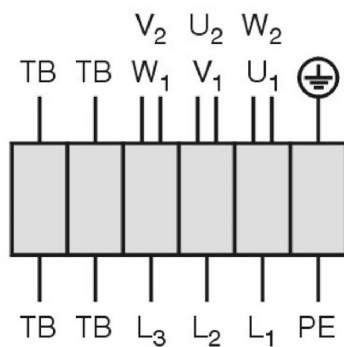

U <sub>1</sub>	braun / brown / brun
V <sub>1</sub>	blau / blue / bleu
W <sub>1</sub>	schwarz / black / noir
U <sub>2</sub>	rot / red / rouge
V <sub>2</sub>	grau / grey / gris
W <sub>2</sub>	orange / orange / orange
TB	weiß / white / blanc
PE	gelb-grün yellow-green jaune-vert

01.006



Typ: **UNO-ME 80-500-4 D FU**  
 Výfuk nahoru - regulovatelný pomocí FM  
 Art.-č.: F09-50025



### stat. účinnost

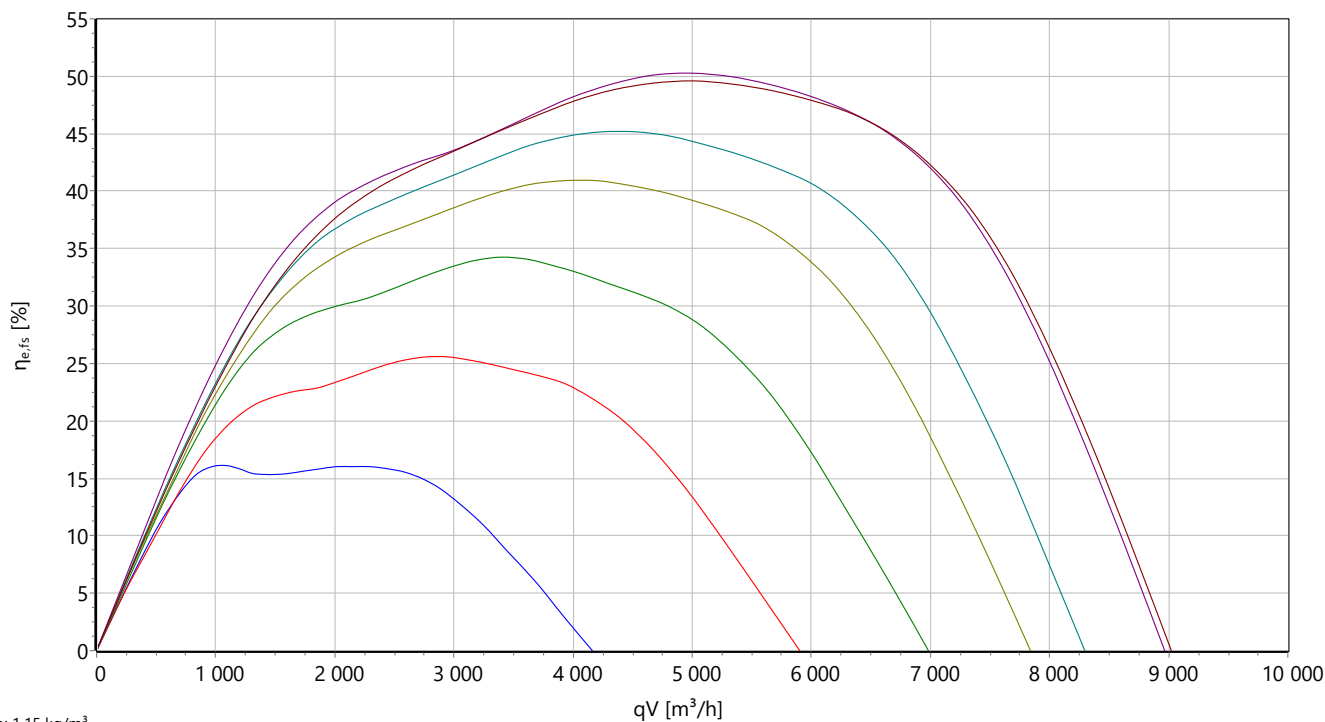

### Příkon

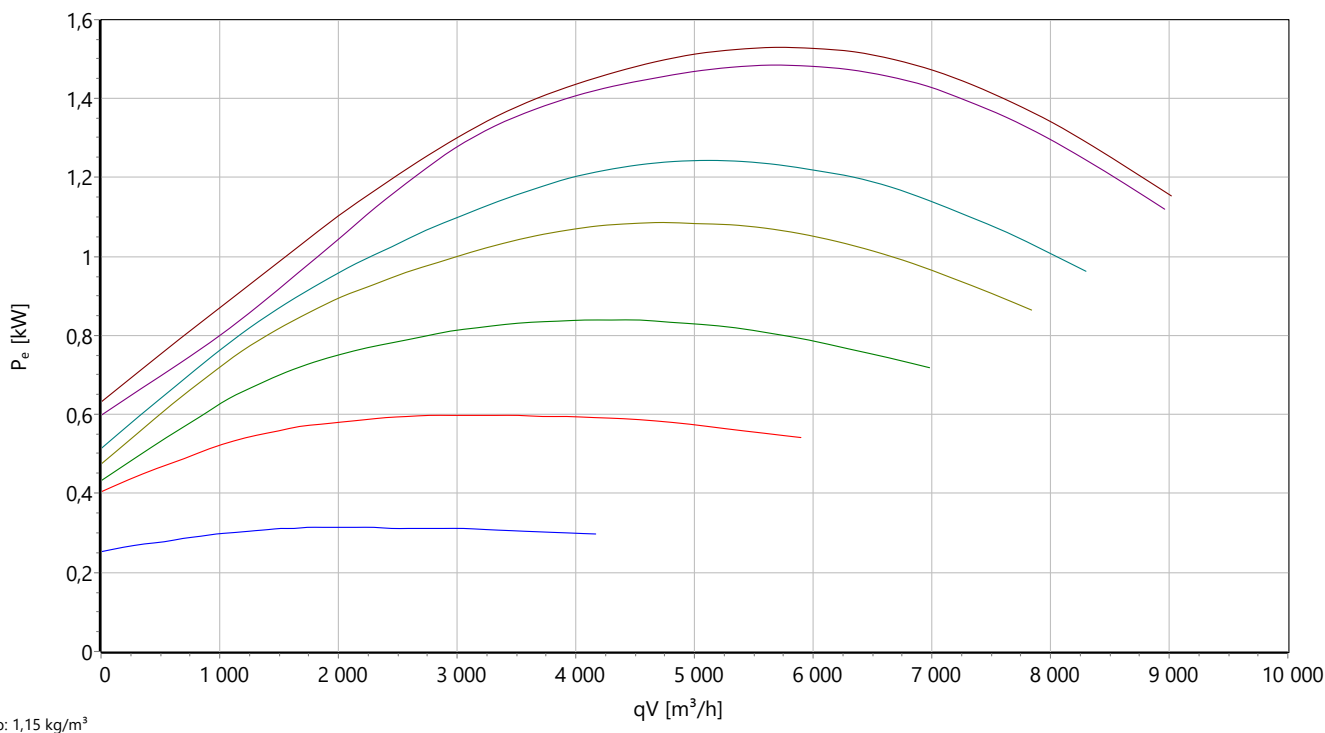



Typ: **UNO-ME 80-500-4 D FU**  
 Výfuk nahoru - regulovatelný pomocí FM  
 Art.-č.: F09-50025



### Akustický výkon

