

# Shut-off damper

# DSU



## Description

Has a turning, circular blade. The blade is stepless adjustable 0–90°. The damper is used when you have lower demands for shut-off capacity. The damper admits an insulation thickness of approx. 50 mm.

The damper can on occasions be used for regulation.

Setting angle  $\alpha$

$\alpha = 0^\circ =$  open blade,  $\alpha = 90^\circ =$  closed blade

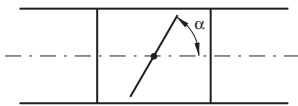

There is a separate assembly, measuring, balancing and maintenance instruction for this product.

Ø 63–1000 fullfills pressure class A in closed position.

The cup at Ø 63–630 can be complemented with the special insulation cup IK at insulation thicker than 50 mm.

## Reinforced blade



## Ordering example



## Dimensions

Ø 63–630

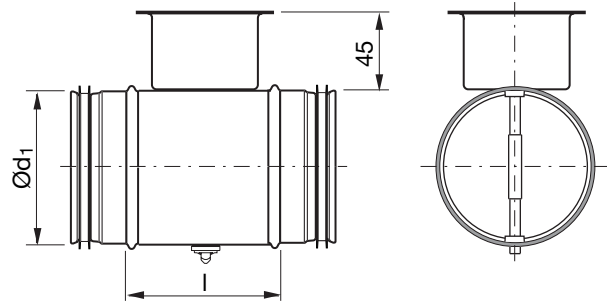

Ø 800–1000

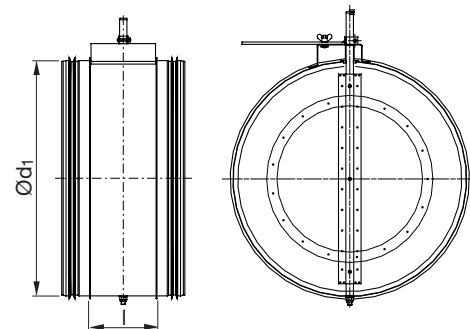

Ød <sub>1</sub> nom	l [mm]	m [kg]	Sealing class past closed blade
63	100	0,30	0
80	100	0,35	0
100	100	0,40	0
112	100	0,44	0
125	100	0,49	0
140	100	0,54	0
150	100	0,57	0
160	100	0,67	0
180	100	0,73	0
200	100	0,86	0
224	100	1,10	0
250	100	1,31	0
280	100	1,51	0
300	100	1,65	0
315	100	1,81	0
355	100	2,00	0
400	100	2,91	1
450	100	3,90	1
500	115	4,92	1
560	115	6,01	1
600	115	6,40	1
630	115	6,92	1
800	230	19,0	1
1000	230	30,0	1



# Shut-off damper

# DSU

Property	Ø 63-315	Ø 400	Ø 500	Ø 630	Ø 800-1000
The blade is set via a knob in a protective cup.	x	x	x	x	
The setting of the blade is read against an embossed scale at the rim of the cup.	x	x	x	x	
The blade is locked with two screws, type Pozidriv (PZD2).	x	x	x	x	
The blade has reinforced locking with a sturdy wing nut.					x
The blade is reinforced.		x	x	x	
The blade is additionally reinforced.					x
With sturdy handle.		x	x	x	
With additionally reinforced handle.					x
With reinforced stop beads.			x	x	
The axle is reinforced.					x
The damper can be delivered prepared for motor.	x	x	x	x	
The damper can be delivered with motor.	x	x	x	x	x

## Technical data

### Pressure drop graphs with noise data for dimensioning

The solid curves show the pressure drop,  $\Delta p_t$ , over the damper as a function of flow  $q$ , and setting angle  $\alpha$ .

The dashed curves give the A-weighted sound power data,  $L_{WA}$ , in dB to the duct.

#### Example

Given Dimension Ø100  
Flow 60 l/s  
Pressure drop 200 Pa

Obtained from graph  
Setting angle 38°  
Sound power level 63 dB (A)

### Ø80

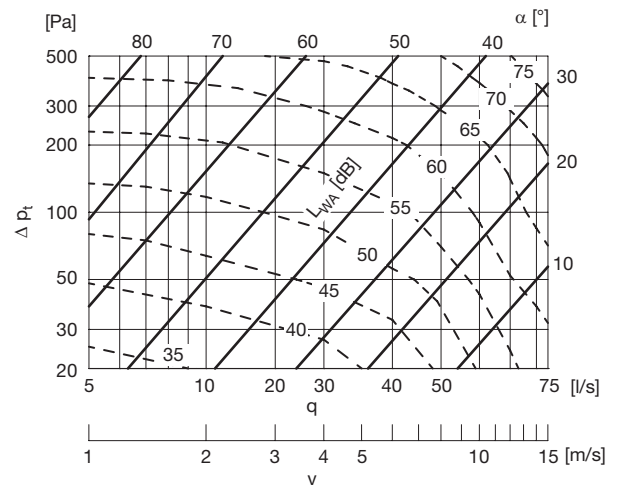

### Ø100

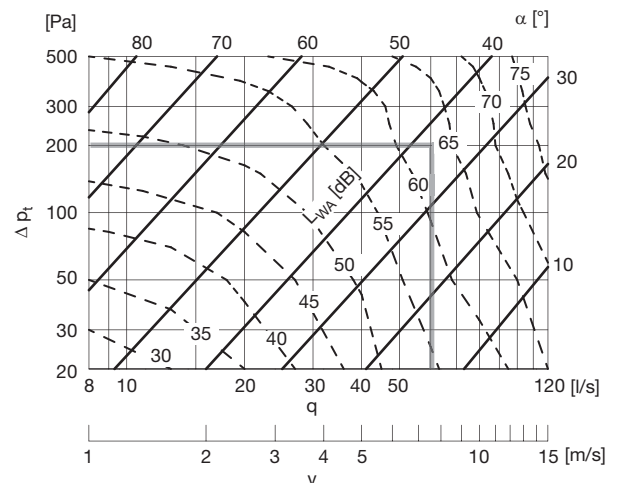

# Shut-off damper

# DSU

**Ø112**

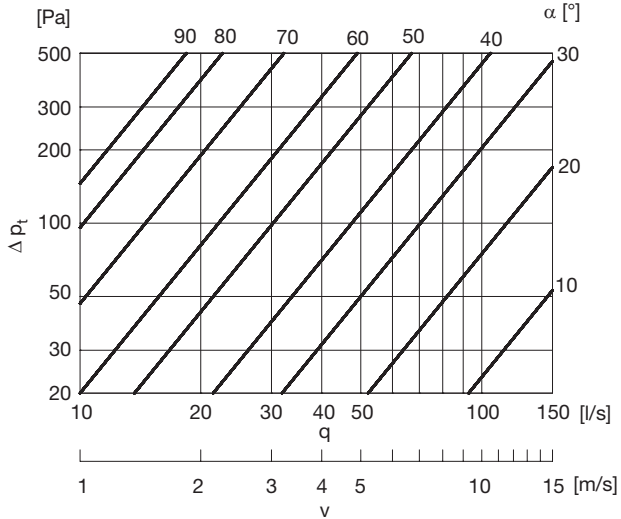

**Ø150**

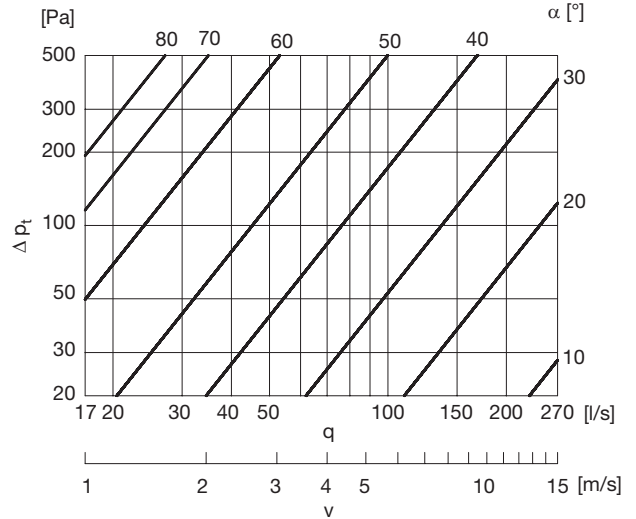

**Ø125**

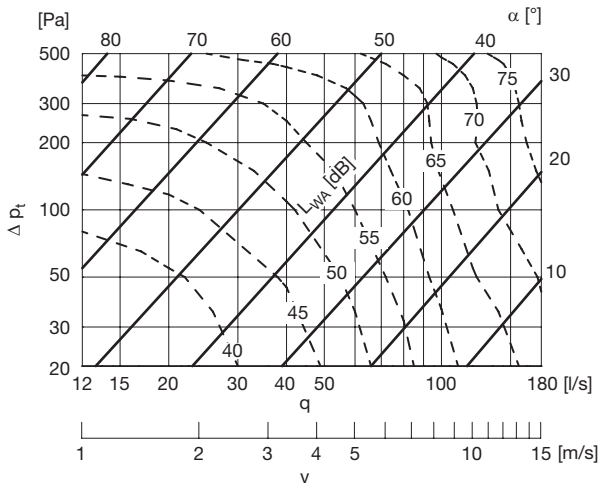

**Ø160**

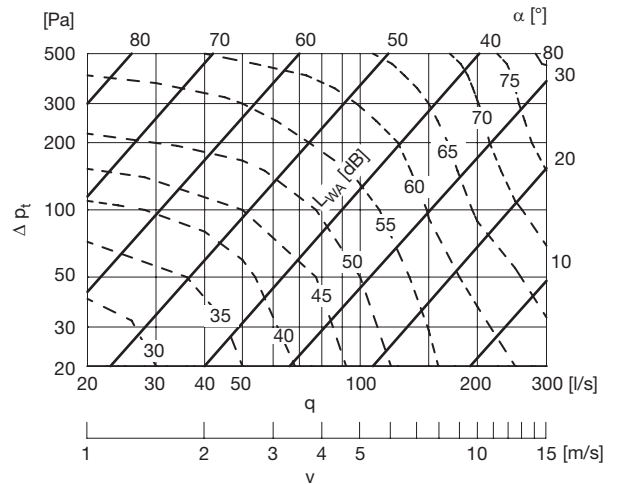

**Ø140**

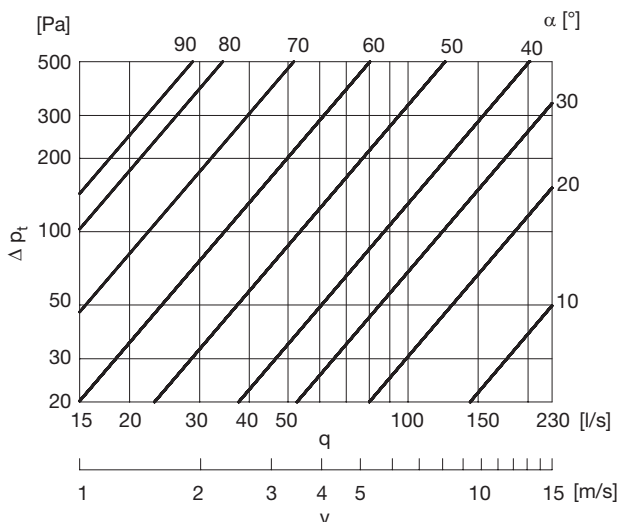

**Ø180**

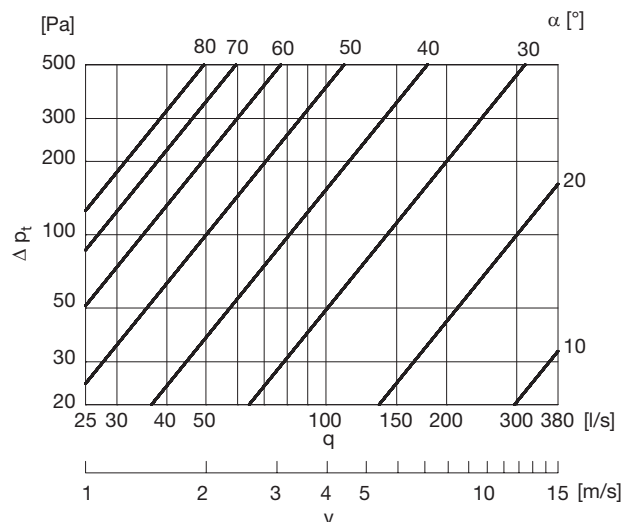

# Shut-off damper

# DSU

**Ø200**

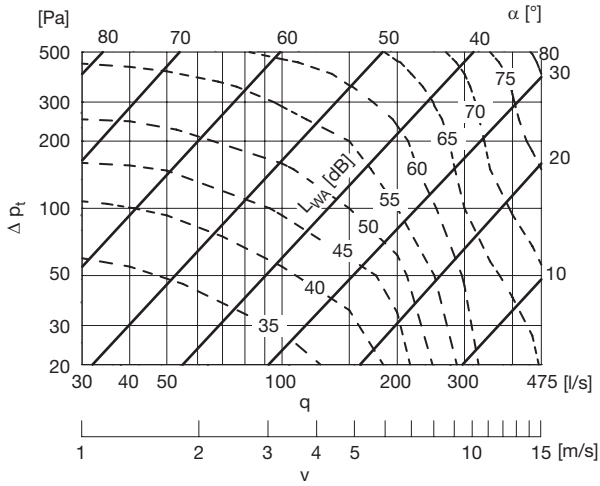

**Ø280**

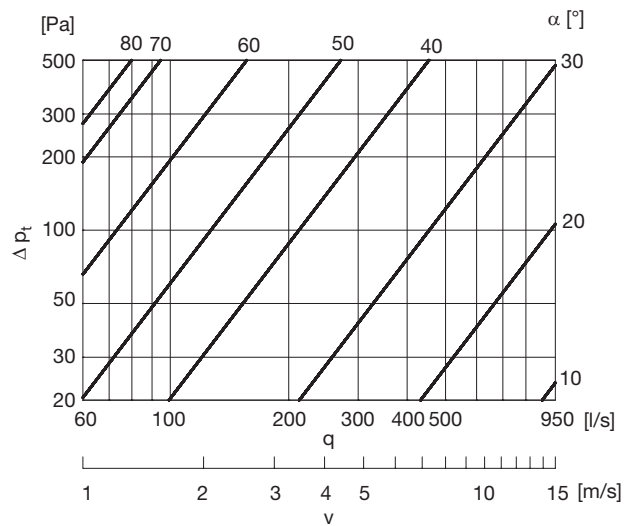

**Ø224**

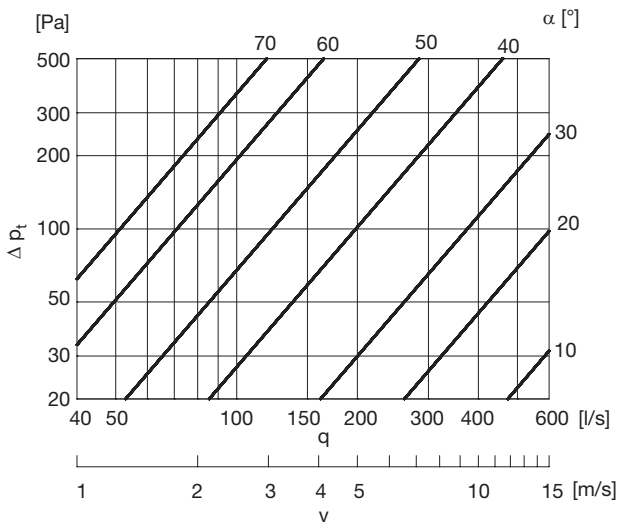

**Ø300**

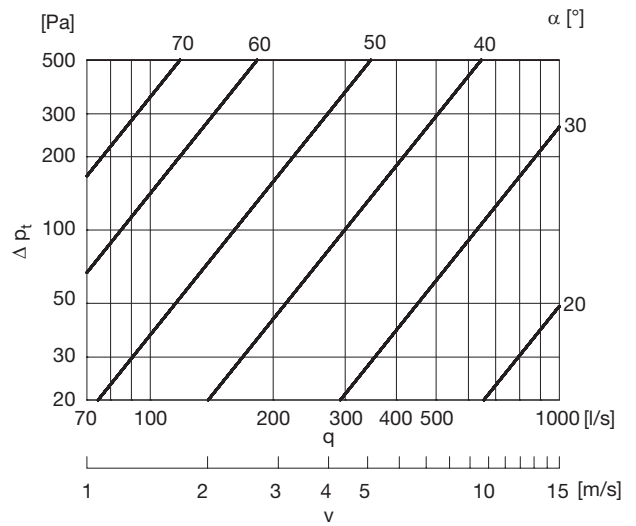

**Ø250**

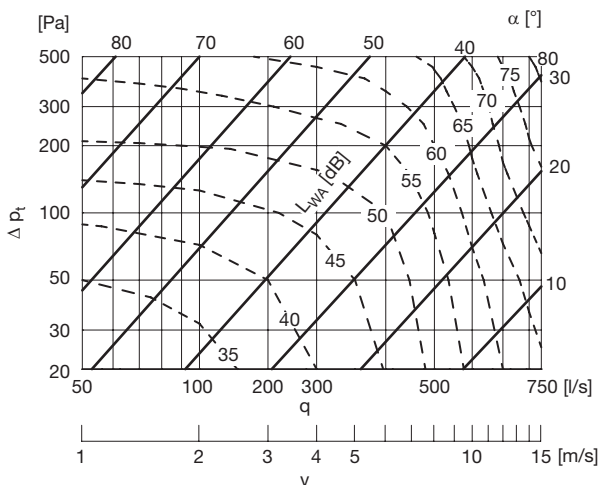

**Ø315**

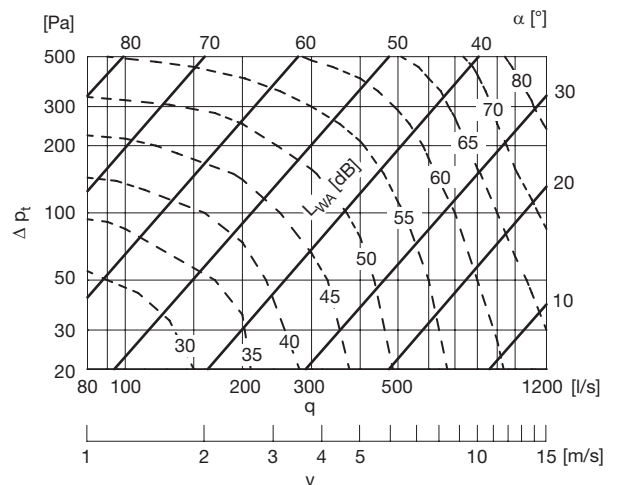

# Shut-off damper

# DSU

**Ø355**

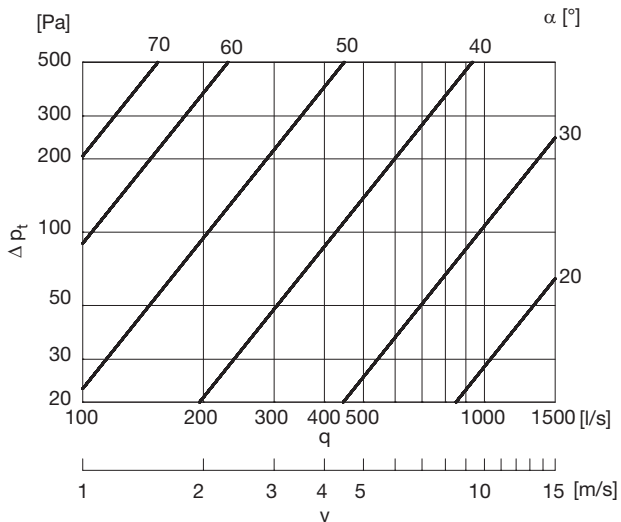

**Ø500**

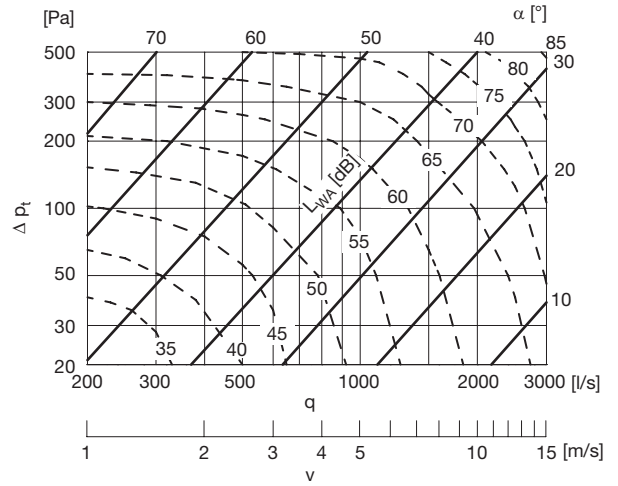

**Ø400**

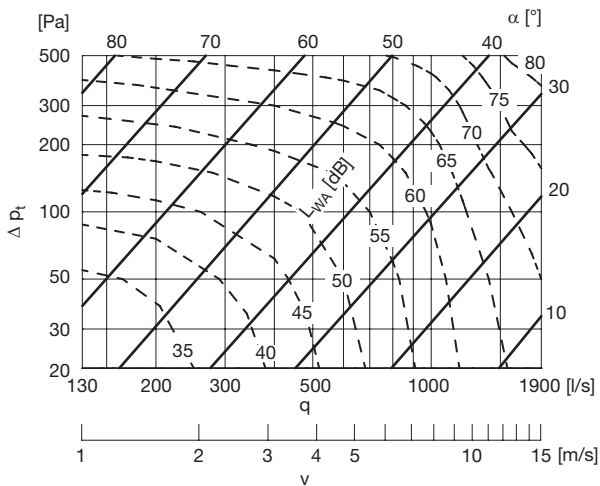

**Ø560**

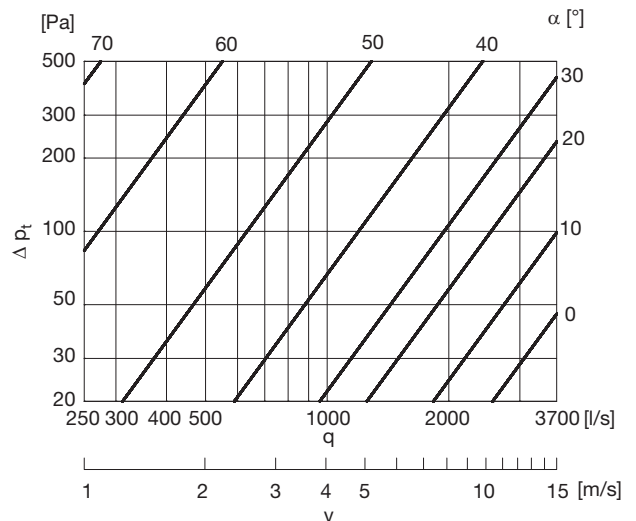

**Ø450**

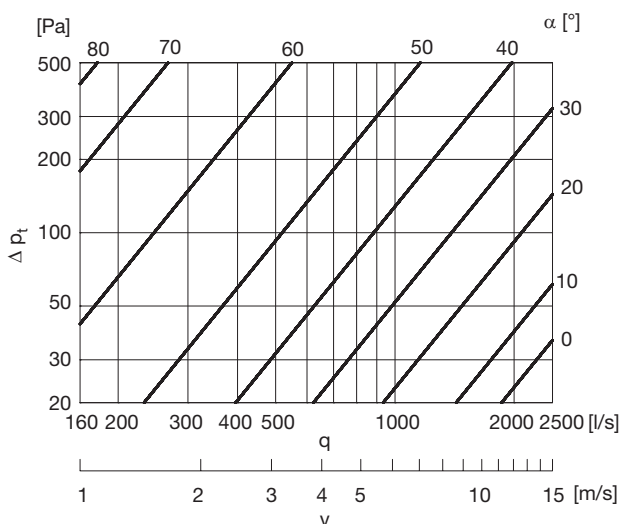

**Ø600**

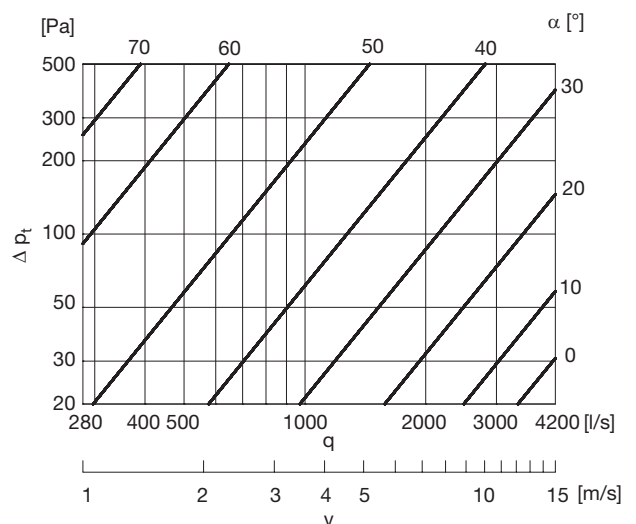

# Shut-off damper

# DSU

**Ø630**

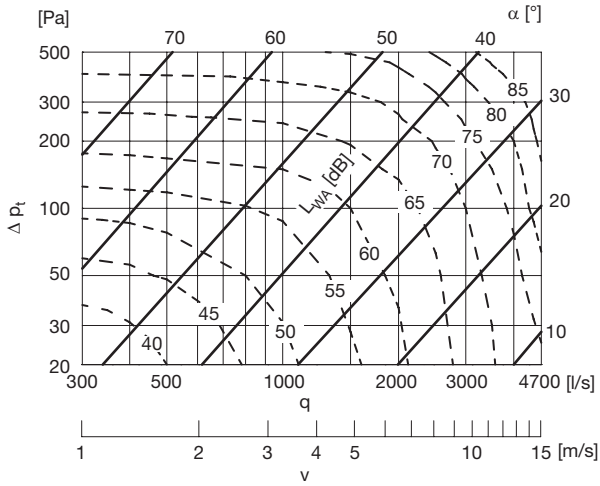

**Ø900**

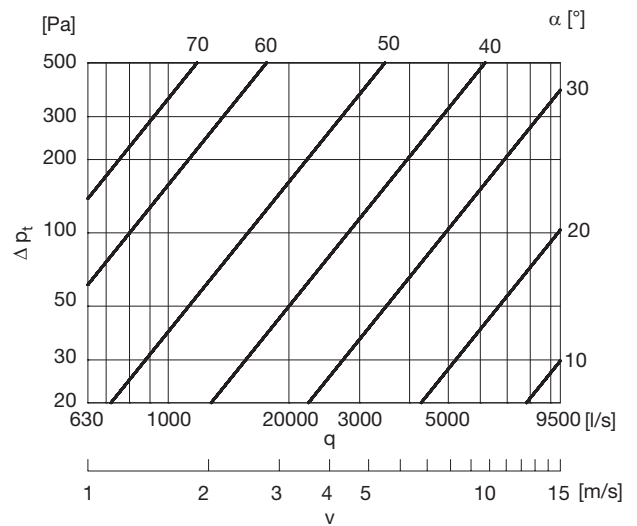

**Ø710**

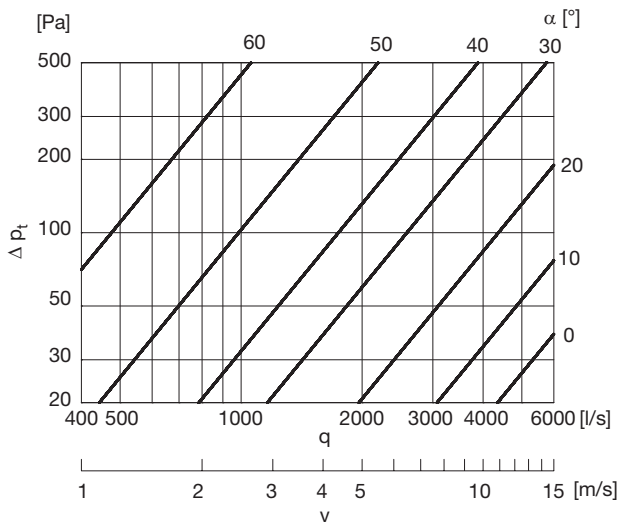

**Ø1000**

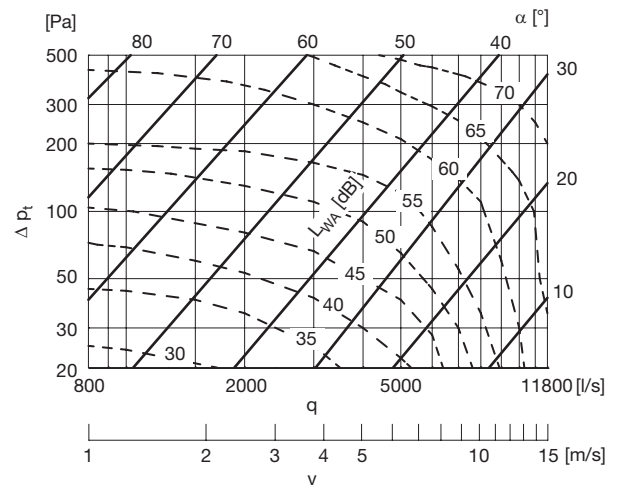

**Ø800**

